

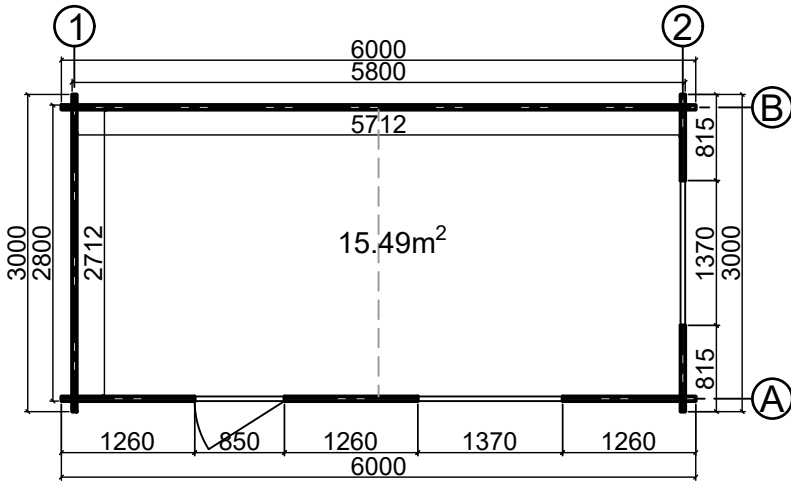



PREMIUM LOG HOUSE

Floor plan

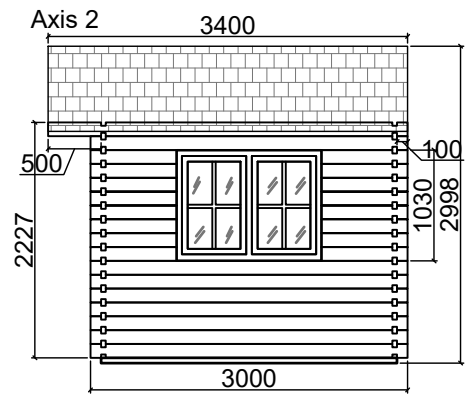
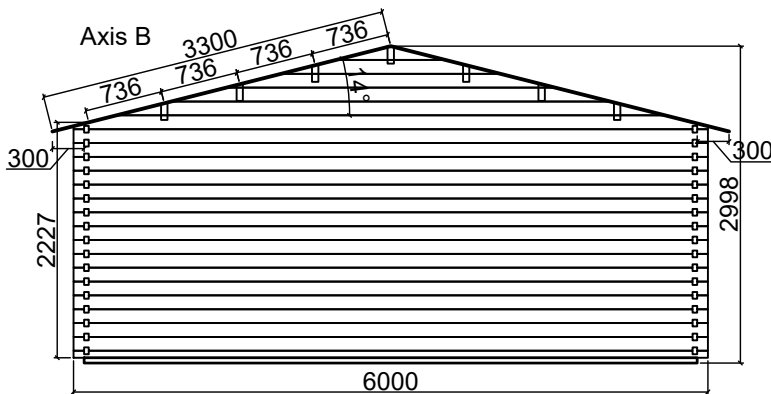
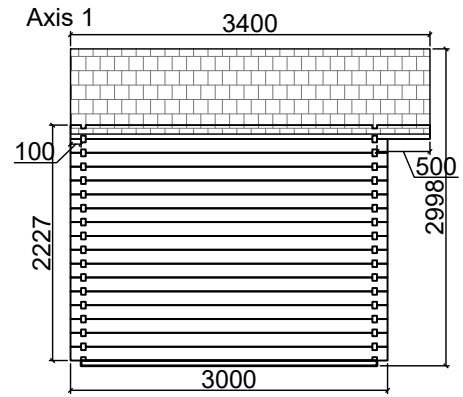
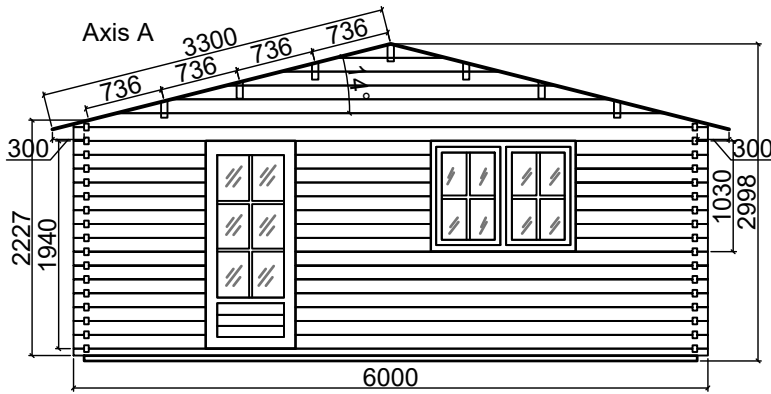
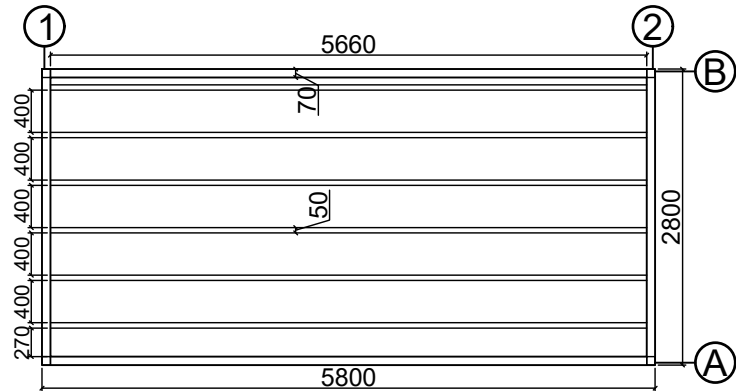

Base plan

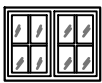

		
CODE	P1	W3
SIZE/mm	850x1940	1370x1030
QUANTITY	1	2
LEFT/RIGHT	0/1	0/2

CABIN SPECIFICATION

WALL LOG:	44mm
SIZE (m):	6x3
SIDE WALL HEIGHT :	2227 mm
RIDGE HEIGHT:	2998 mm
FLOOR AREA m ² :	15.49
ROOF AREA m ² :	22.44
FLOOR BOARDS mm:	19