

Floor plan

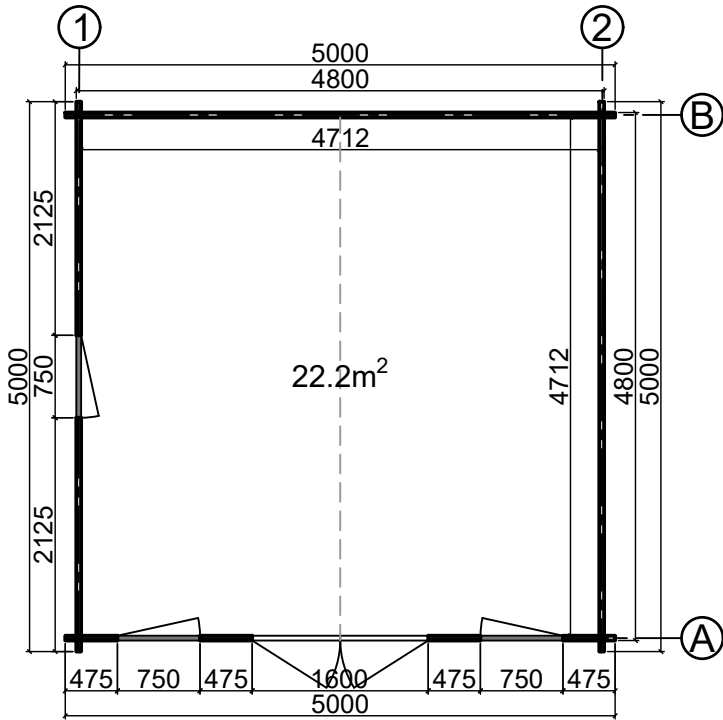

Base plan

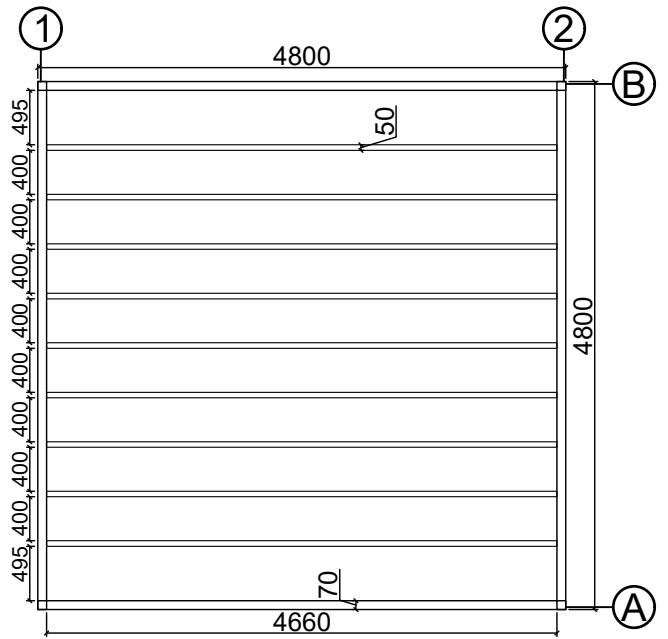

Axis A

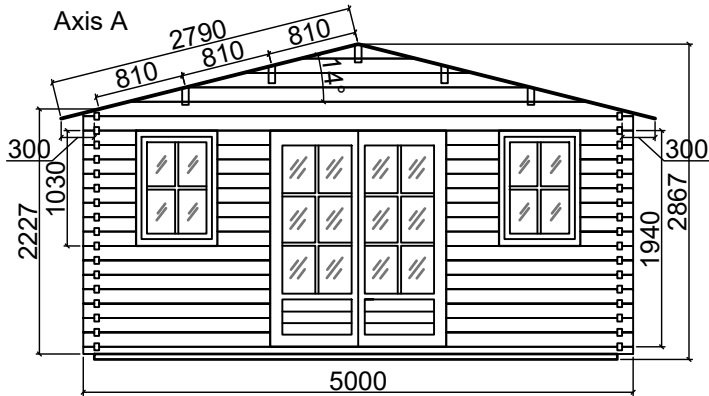

Axis 1

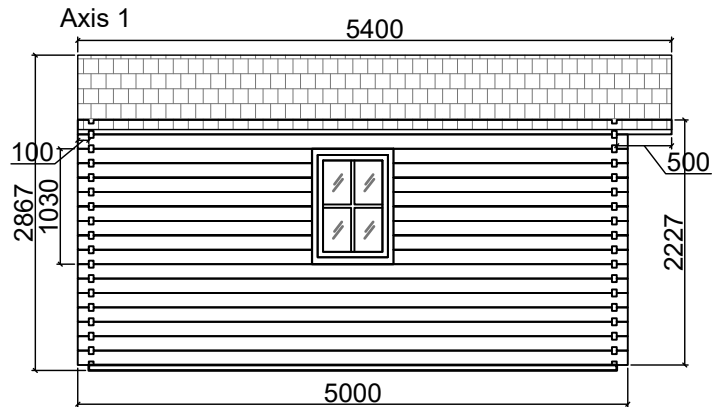

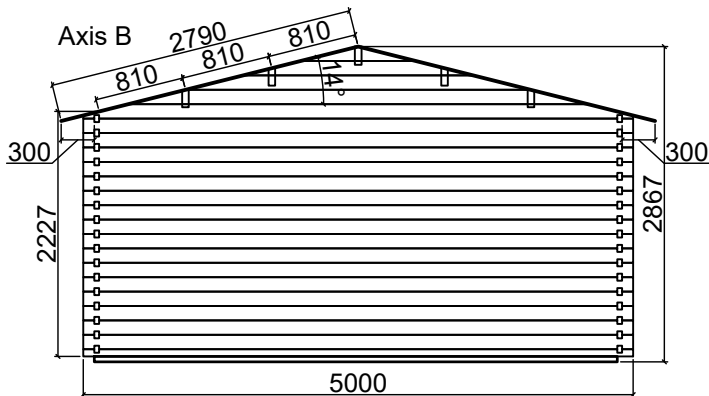

Axis B

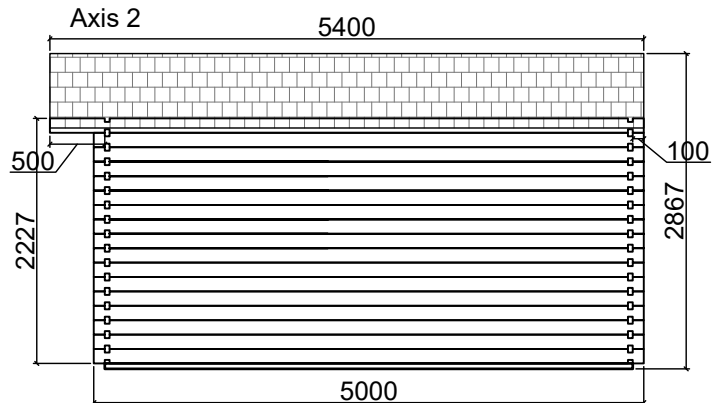

Axis 2



		
CODE	P3	W1
SIZE/mm	1600x1940	750x1030
QUANTITY	1	3
LEFT/RIGHT	0/1	1/2

CABIN SPECIFICATION

WALL LOG:	44mm
SIZE (m):	5x5
SIDE WALL HEIGHT :	2227mm
RIDGE HEIGHT:	2867 mm
FLOOR AREA m ² :	22.2
ROOF AREA m ² :	30.13
FLOOR BOARDS mm:	19