

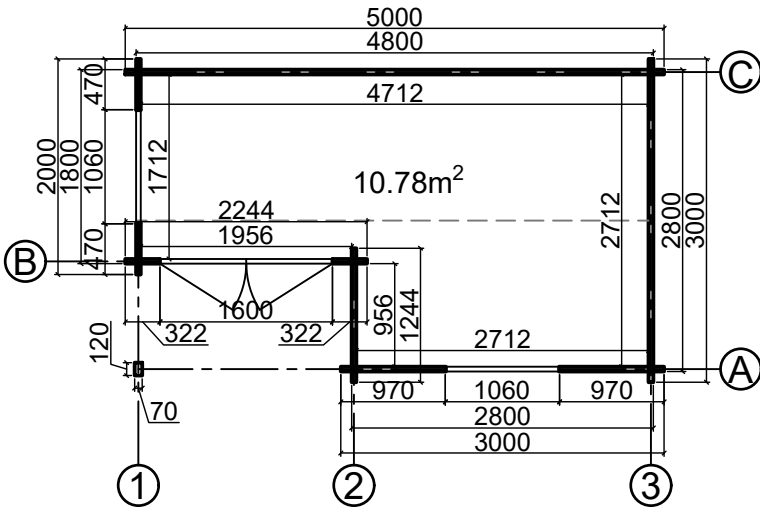

Floor plan

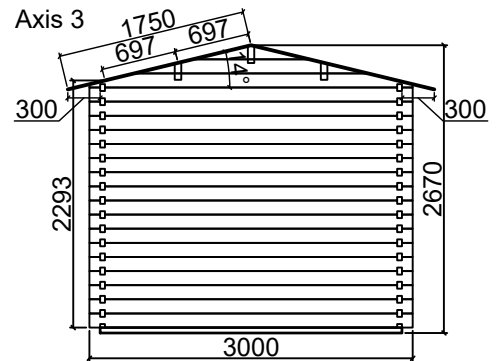

Base plan

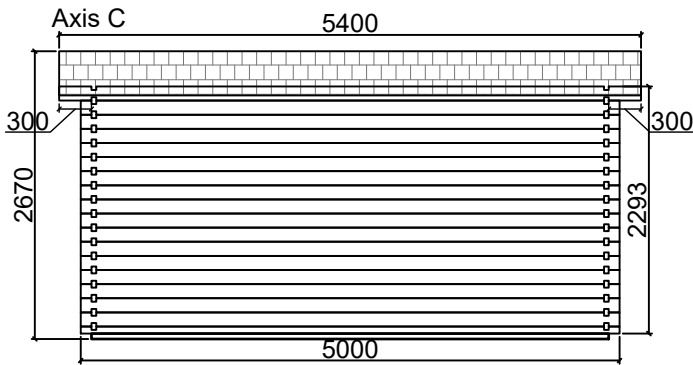
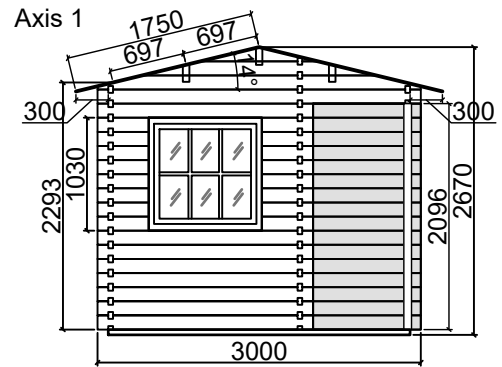
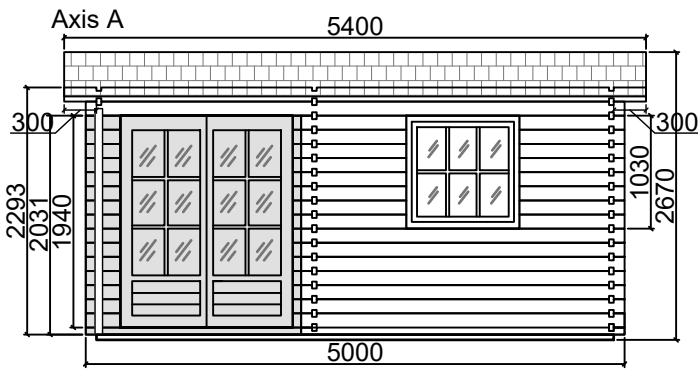
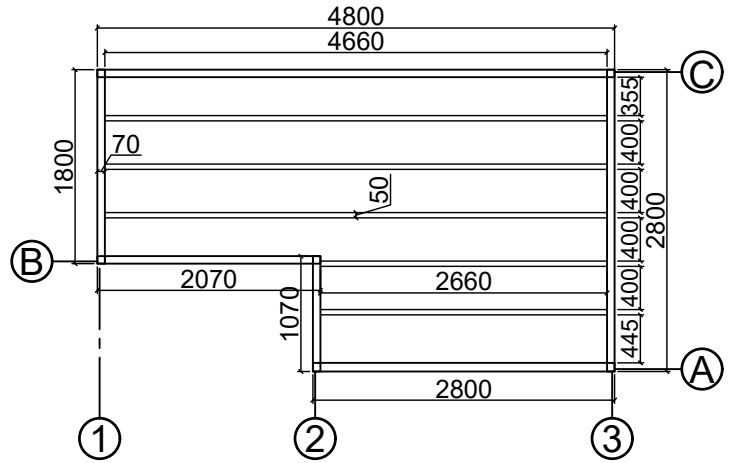

		
CODE	P3	W2
SIZE/mm	1600x1940	1060x1030
QUANTITY	1	2
LEFT/RIGHT	0/1	0/2

CABIN SPECIFICATION

WALL LOG:	44mm
SIZE (m):	5x3
SIDE WALL HEIGHT :	2293 mm
RIDGE HEIGHT:	2670 mm
FLOOR AREA m ² :	10.78
ROOF AREA m ² :	18.9
FLOOR BOARDS mm:	19