

Floor plan

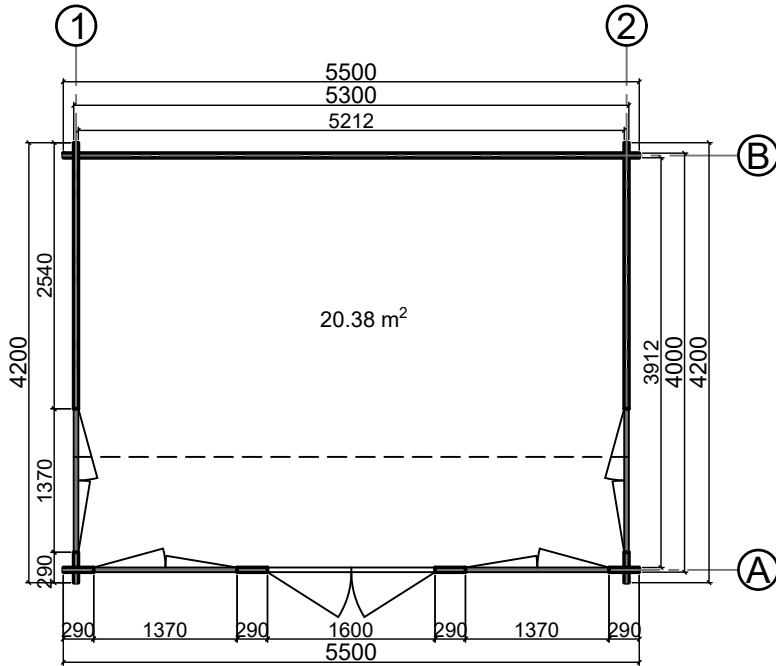

Base plan

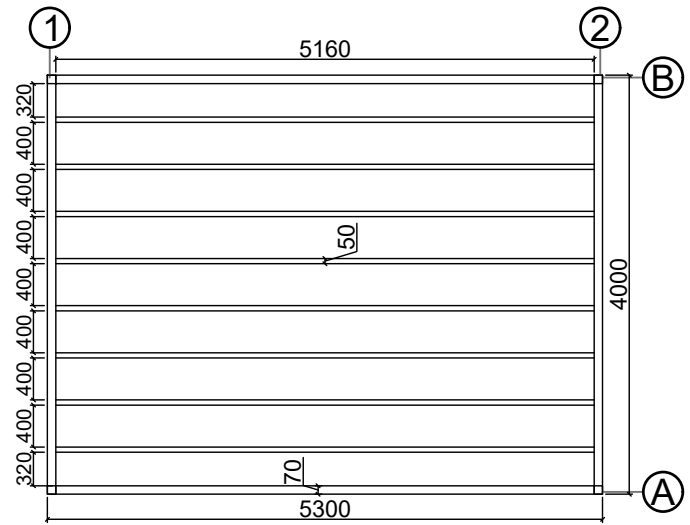

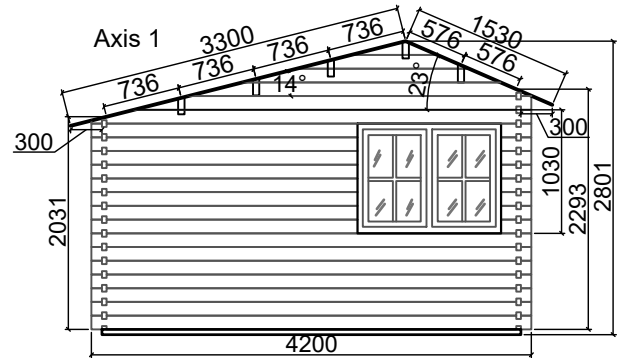
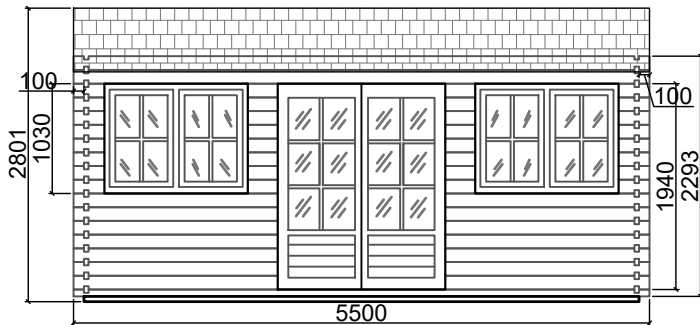

Axis A

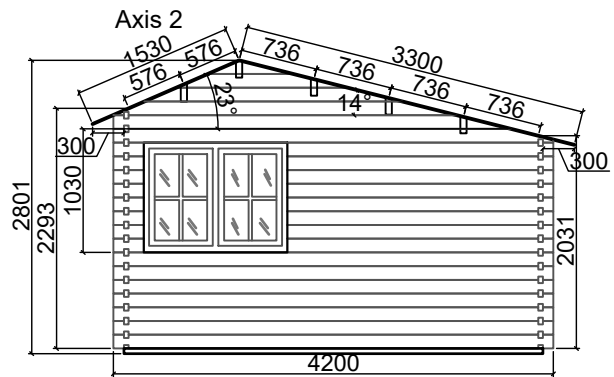
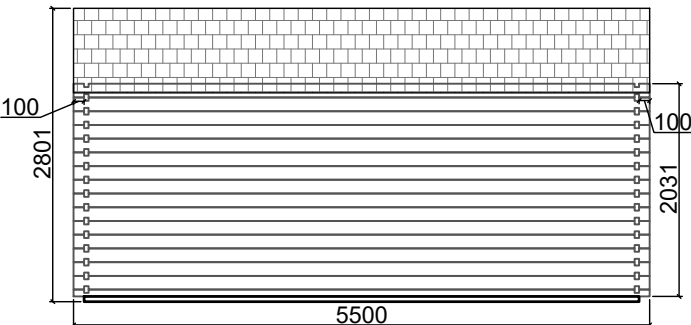

Axis B



		
CODE	P3	W3
SIZE/mm	1600x1940	1370x1030
QUANTITY	1	4
LEFT/RIGHT	0/1	2/2

CABIN SPECIFICATION

WALL LOG:	44mm
SIZE (m):	5.5x4.2
SIDE WALL HEIGHT :	2031mm
RIDGE HEIGHT:	2801 mm
FLOOR AREA m ² :	20.38
ROOF AREA m ² :	26.57
FLOOR BOARDS mm:	19