

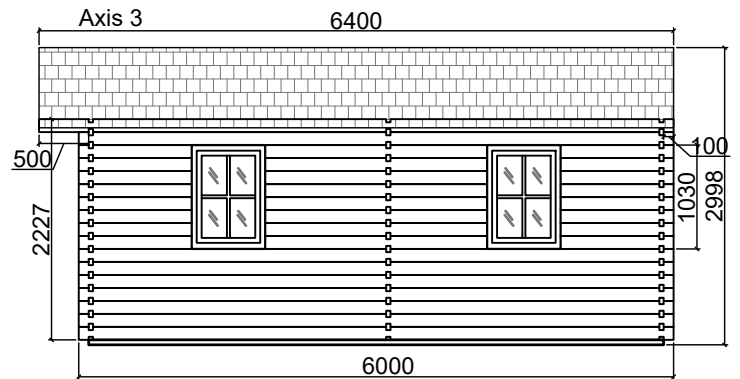

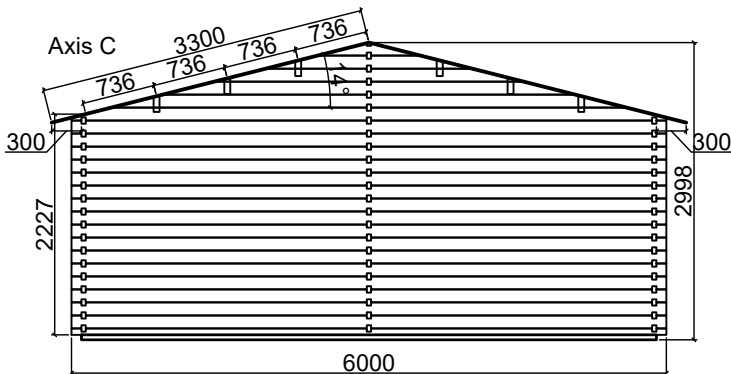

Floor plan

Base plan

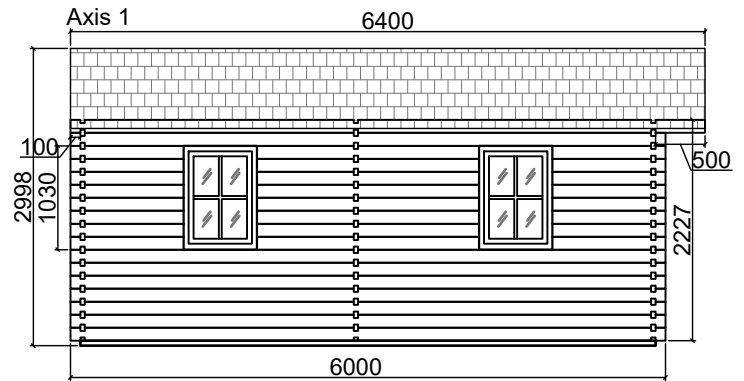
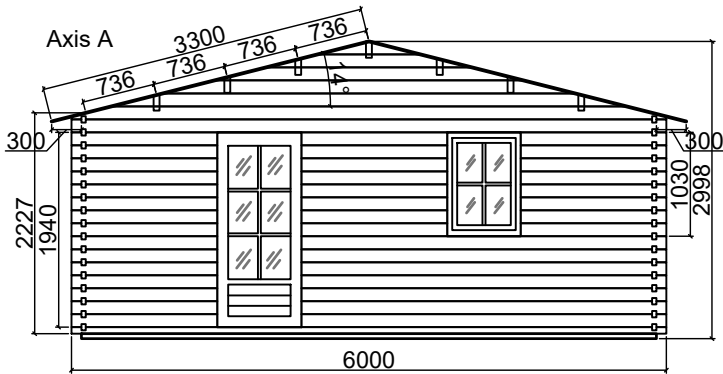
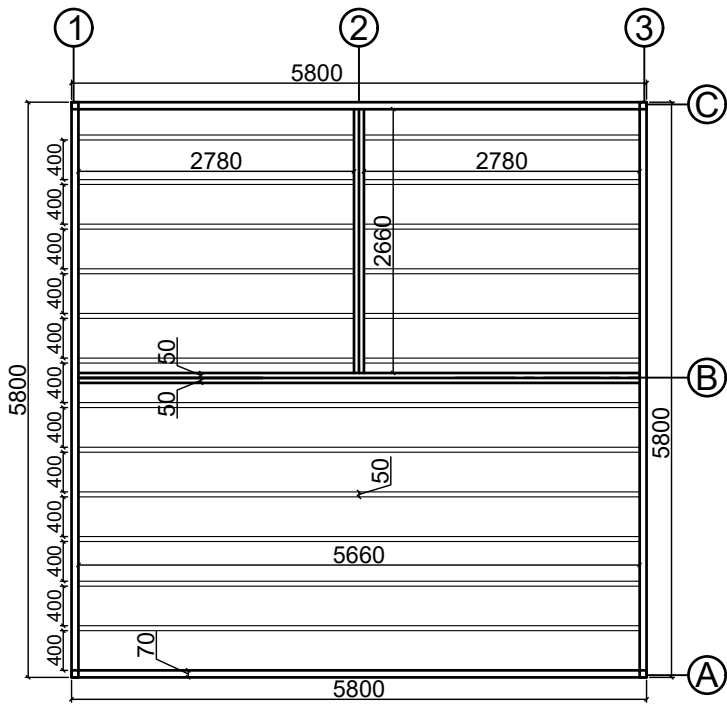
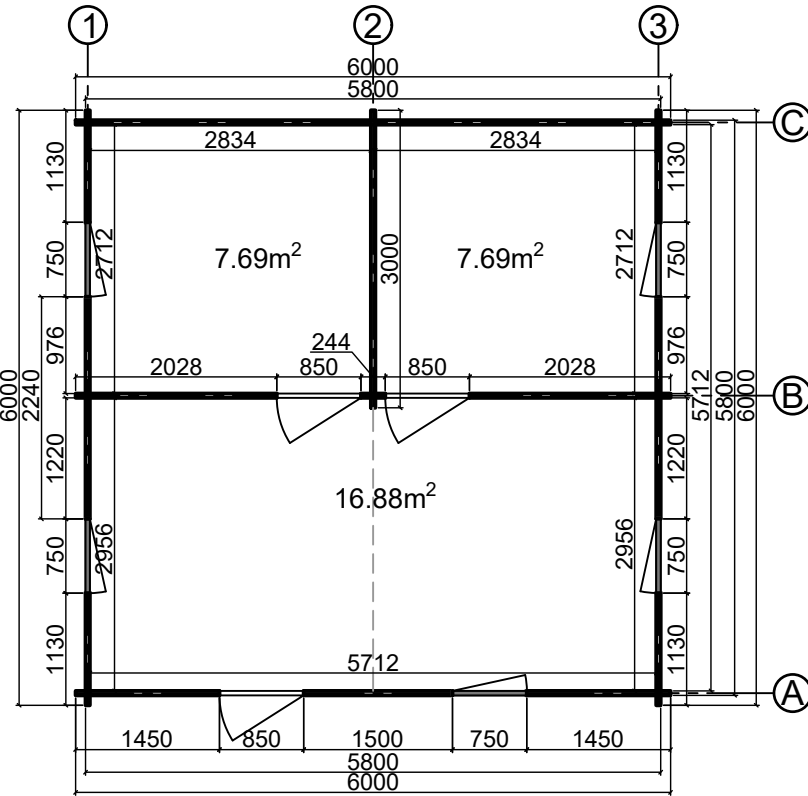

			
CODE	P1	G4	W1
SIZE/mm	850x1940	850x1940	750x1030
QUANTITY	1	2	5
LEFT/RIGHT	0/1	0/2	2/3

CABIN SPECIFICATION

WALL LOG:	44mm
SIZE (m):	6x6
SIDE WALL HEIGHT :	2227mm
RIDGE HEIGHT:	2998 mm
FLOOR AREA m ² :	32.26
ROOF AREA m ² :	42.24
FLOOR BOARDS mm:	19