

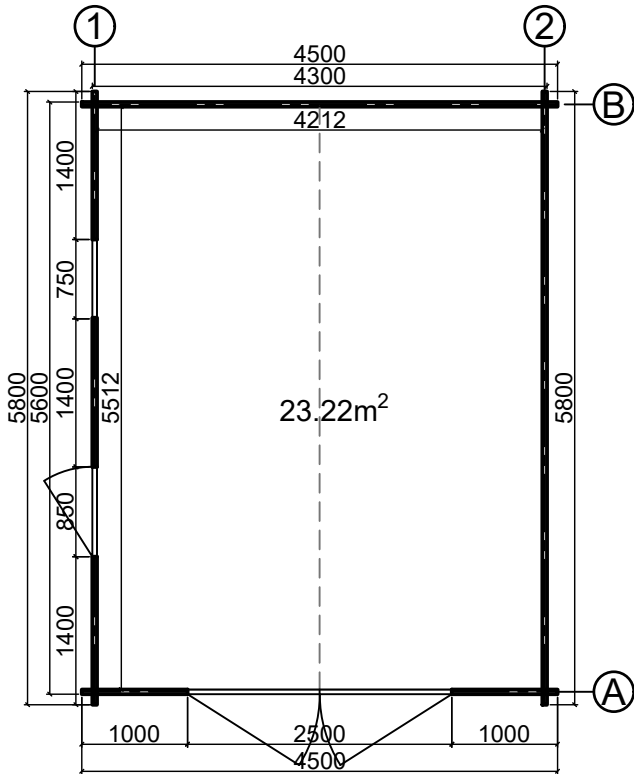

Floor plan

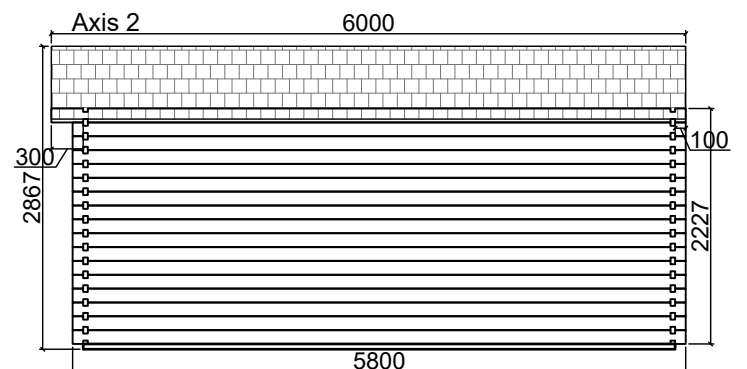

Base plan

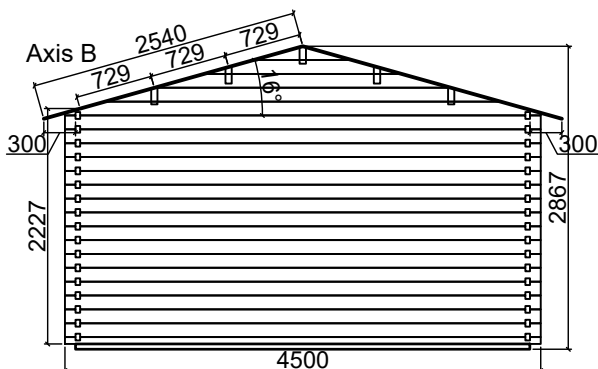
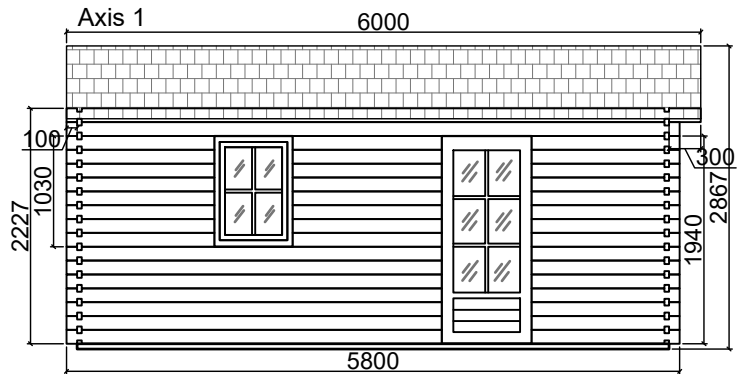
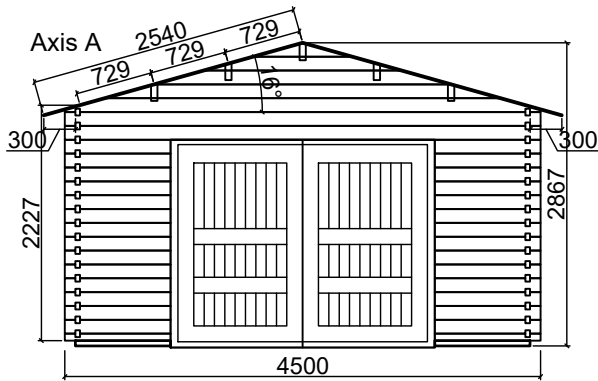
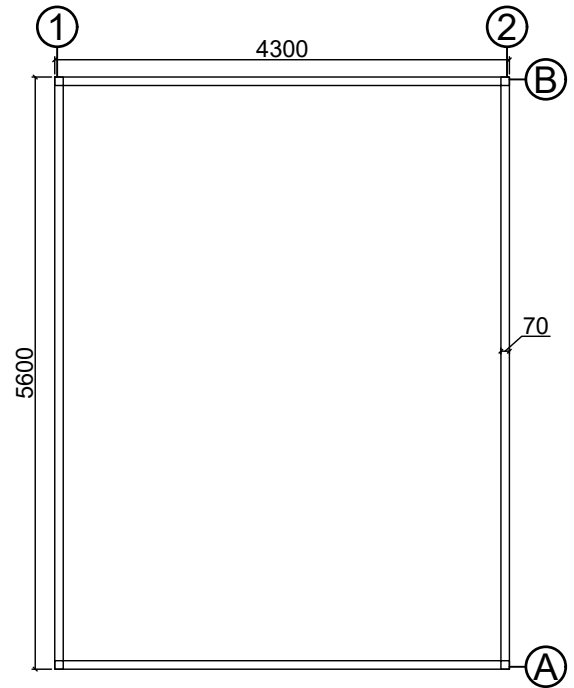
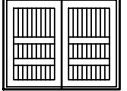

			
CODE	G5	P1	W1
SIZE/mm	2500x1940	850x1940	750x1030
QUANTITY	1	1	1
LEFT/RIGHT	0/1	0/1	0/1

CABIN SPECIFICATION

WALL LOG:	44mm
SIZE (m):	4.5x5.8
SIDE WALL HEIGHT :	2227 mm
RIDGE HEIGHT:	2867 mm
FLOOR AREA m ² :	23.22
ROOF AREA m ² :	30.48
FLOOR BOARDS mm:	No floor