

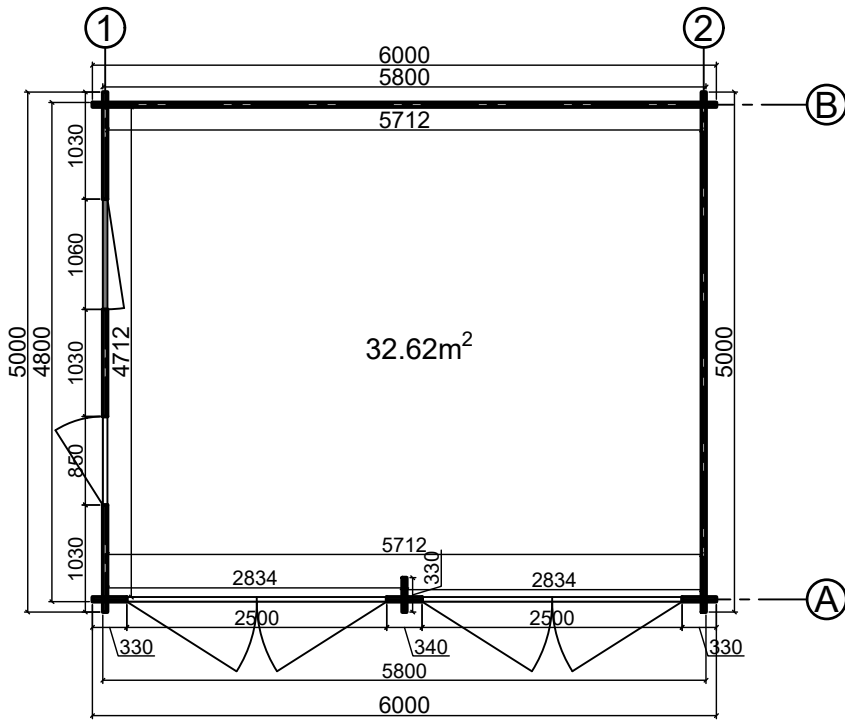

Floor plan

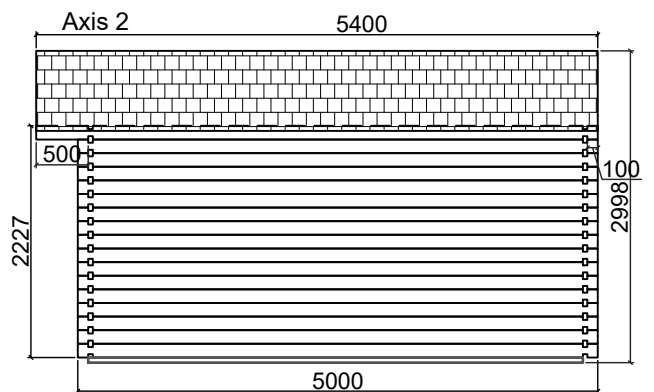

Base plan

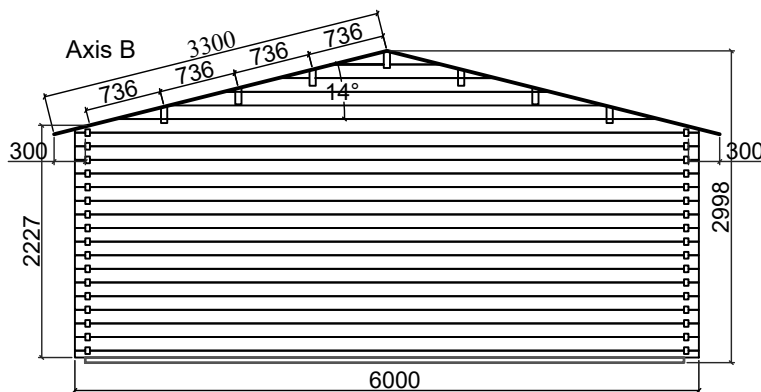
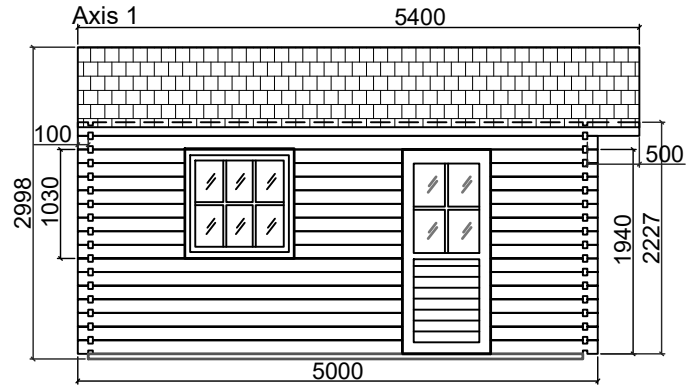
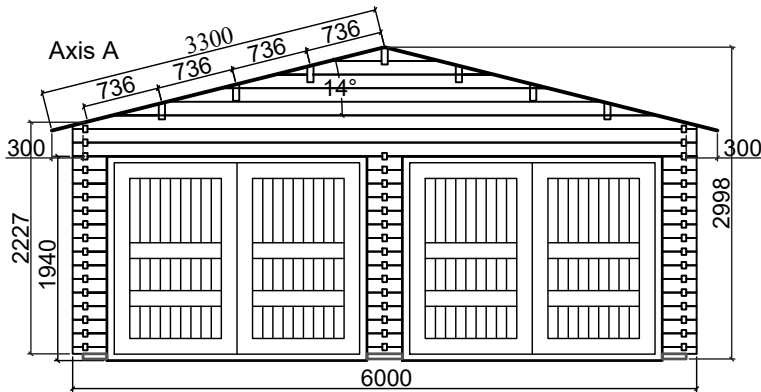
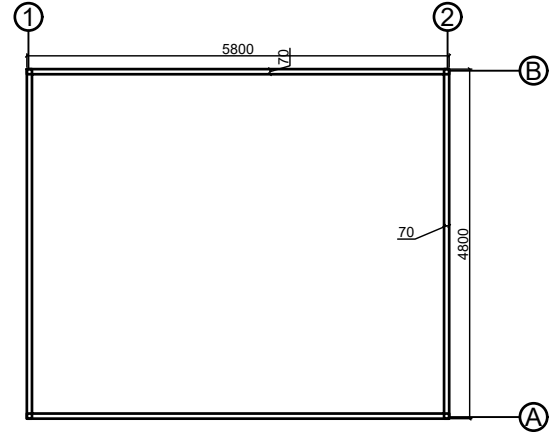
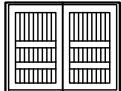

| |  |  |  |
|------------|---|---|---|
| CODE | G5 | G1 | W2 |
| SIZE/mm | 2500x1940 | 850x1940 | 1060x1030 |
| QUANTITY | 2 | 1 | 1 |
| LEFT/RIGHT | 0/2 | 0/1 | 0/1 |

CABIN SPECIFICATION

| | |
|-----------------------------|----------|
| WALL LOG: | 44mm |
| SIZE (m): | 6x5 |
| SIDE WALL HEIGHT : | 2227 mm |
| RIDGE HEIGHT: | 2998 mm |
| FLOOR AREA m ² : | 32.62 |
| ROOF AREA m ² : | 35.64 |
| FLOOR BOARDS mm: | No floor |